

OAKVILLE STONE



As perfect as natural can be™

WHO WE ARE



Oakville Stone prides itself on providing the highest quality natural stone products the earth has to offer. It is our continuous goal to provide a level of service that is unmatched in the natural stone industry. Our commitment to quality, service, and sustainability has helped us become North America's most highly regarded producer and supplier of imported landscape stone.

Our global supply chain is built on exclusive overseas partnerships, a large staff of our own company inspectors, and a solid transportation framework which enables us to not only provide all the products you see in our catalog, but any natural stone product you may find in the market.

With a vast and growing dealer base, as well as multiple distribution centers, Oakville Stone products are available for immediate delivery for any size project throughout North America.



CONTENTS



Oakville Slate Grey

PRODUCTS

- 8 Oakville Antique Limestone

- 12 Oakville Autumn Brown

- 16 Oakville Black Limestone

- 20 Oakville Blue Ice

- 24 Oakville Brown Wave

- 28 Oakville Buff

- 32 Oakville Hampton Limestone

- 36 Oakville Highland Black 

- 38 Oakville Imperial Black

- 42 Oakville Ivory Coast

- 46 Oakville Rainbow

- 50 Oakville Rustic Plains

- 54 Oakville Sagebrush

- 58 Oakville Siberian Grey 

- 60 Oakville Silver Pearl 

- 62 Oakville Slate Grey

- 66 Oakville Thermal Bluestone

APPLICATIONS

- 72 Paving

- 73 Pattern Crates

- 74 Handcut Paving

- 75 Edge Pavers

- 76 Rockface Treads

- 77 Rebated Treads

- 78 Bullnose Coping

- 79 Straight Edge Coping

- 80 Steps

- 81 Fillers

- 82 Pier Caps

- 83 Wall Caps

- 84 BBQ Slabs

- 85 Slabs



Oakville Imperial Black

INSTALLATION

- 88 Steps and Fillers Installation

- 90 Dry Lay Installation

- 91 Wet Lay Installation

- 92 Considerations When Using Natural Stone

OUR STONE

As perfect as natural can be™

Please visit www.oakvillestone.com to view various installation photos of our products.

Oakville Antique Limestone

CLASSIFICATION

LIMESTONE

FINISH

ACID WASH

ORIGIN

CHINA



Oakville Antique Limestone



BBQ Slabs ❤️

Size (in)	Toronto
36x96x2	🇨🇦
48x96x2	🇨🇦



Bullnose Coping

Size (in)	Toronto
12x48x2	🇨🇦



Edge Pavers ❤️

Size (cm)	Toronto
30x60x2.5	🇨🇦



Fillers ❤️

Size (in)	Toronto
6x31x7	🇨🇦



Pier Caps ❤️

Size (in)	Toronto
24x24x3	🇨🇦
28x28x3	🇨🇦



Wall Caps ❤️

Size (in)	Toronto
14x48x2	🇨🇦



Paving

Size (cm)	Toronto
30x30x2.5	🇨🇦
30x60x2.5	🇨🇦
45x60x2.5	🇨🇦
60x60x2.5	🇨🇦
60x90x2.5	🇨🇦
Pattern 1	🇨🇦



Rockface Treads

Size (in)	Toronto
12x48x2	🇨🇦
12x72x2	🇨🇦
14x48x2	🇨🇦
14x72x2	🇨🇦
16x48x2	🇨🇦
16x72x2	🇨🇦



Steps

Size (in)	Toronto
16x48x7	🇨🇦
16x60x7	🇨🇦
16x72x7	🇨🇦
16x96x7	🇨🇦



Straight Edge Coping

Size (in)	Toronto
12x48x2	🇨🇦



Rebated Treads

Size (in)	Toronto
12x48x2	🇨🇦

Oakville Autumn Brown

CLASSIFICATION

QUARTZITIC SANDSTONE

FINISH

NATURAL CLEFT

ORIGIN

INDIA



Oakville Autumn Brown



BBQ Slabs

Size (in)	New Jersey
36x96x2	



Bullnose Coping

Size (in)	Toronto	New Jersey
12x48x2		
14x72x2		



Edge Pavers

Size (cm)	Toronto
30x60x2.5	



Fillers

Size (in)	Toronto
6x31x7	



Paving

Size (cm)	Toronto	New Jersey
30x30x2.5		
30x60x2.5		
45x60x2.5		
60x60x2.5		
60x90x2.5		
Pattern 1		
Pattern 2		



Rockface Treads

Size (in)	Toronto	New Jersey
12x48x2		
12x72x2		
12x96x2		
14x72x2		
16x48x2		
16x72x2		
18x72x2		
24x72x2		



Steps

Size (in)	Toronto	New Jersey
16x48x7		
16x60x7		
16x72x7		
16x96x7		



Pier Caps

Size (in)	Toronto	New Jersey
24x24x3		
28x28x3		



Wall Caps

Size (in)	Toronto	New Jersey
14x48x2		

Oakville Black Limestone

CLASSIFICATION

LIMESTONE

FINISH

NATURAL CLEFT

ORIGIN

INDIA



Oakville Black Limestone



BBQ Slabs

Size (in)	Toronto
36x72x2	



Bullnose Coping

Size (in)	Toronto	New Jersey
12x48x2		



Edge Pavers

Size (cm)	Toronto
30x60x2.5	



Fillers

Size (in)	Toronto
6x31x6	



Pier Caps

Size (in)	Toronto	New Jersey
24x24x3		
28x28x3		



Wall Caps

Size (in)	Toronto
12x48x2	
14x48x2	



Paving

Size (cm)	Toronto	New Jersey
30x30x2.5		
30x60x2.5		
45x60x2.5		
60x60x2.5		
60x90x2.5		
Pattern 1		



Rockface Treads

Size (in)	Toronto	New Jersey
12x48x2		
12x60x2		
12x72x2		
14x48x2		
14x72x2		
16x48x2		
16x72x2		



Steps

Size (in)	Toronto
16x48x6	
16x60x6	
16x72x6	
16x96x6	



Rebated Treads

Size (in)	Toronto
12x48x2	

Oakville Blue Ice

CLASSIFICATION

QUARTZITIC SANDSTONE

FINISH

NATURAL CLEFT

ORIGIN

INDIA



Oakville Blue Ice



BBQ Slabs

Size (in)	Toronto	New Jersey	Savannah
36x96x2			
48x96x2			



Bullnose Coping

Size (in)	Toronto	New Jersey	Savannah
12x48x2			



Edge Pavers

Size (cm)	Toronto
30x60x2.5	



Fillers

Size (in)	Toronto
6x31x7	



Pier Caps

Size (in)	Toronto	New Jersey
24x24x3		
28x28x3		



Wall Caps

Size (in)	Toronto	New Jersey
12x48x2		
14x48x2		



Paving

Size (cm)	Toronto	New Jersey	Savannah
30x30x2.5			
30x45x2.5			
30x60x2.5			
45x45x2.5			
45x60x2.5			
45x90x2.5			
60x60x2.5			
60x90x2.5			
Pattern 1			
Pattern 2			
Handcut Pattern 1			



Rockface Treads

Size (in)	Toronto	New Jersey	Savannah
12x48x2			
12x60x2			
12x72x2			
12x96x2			
14x48x2			
14x72x2			
14x96x2			
16x48x2			
16x72x2			
18x72x2			
18x96x2			
24x72x2			
24x96x2			



Steps

Size (in)	Toronto	New Jersey
16x48x6		
16x72x6		
16x48x7		
16x60x7		
16x72x7		
16x96x7		



Straight Edge Coping

Size (in)	Toronto	New Jersey	Savannah
12x48x2			



Rebated Treads

Size (in)	Toronto
12x48x2	

Oakville Brown Wave

CLASSIFICATION

SANDSTONE

FINISH

FLAMED

ORIGIN

CHINA



Oakville Brown Wave



Paving

Size (cm)	New Jersey
30x60x3	
60x60x3	
60x90x3	
Pattern 2	



Rockface Treads

Size (in)	New Jersey
12x60x2	
12x72x2	
12x96x2	
14x72x2	
14x96x2	
18x72x2	
18x96x2	
24x72x2	
24x96x2	

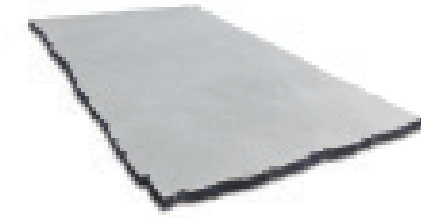

Slabs

Size (in)	New Jersey
48x96x2	

Oakville Buff

CLASSIFICATION

SANDSTONE

FINISH

NATURAL CLEFT

ORIGIN

INDIA



Oakville Buff

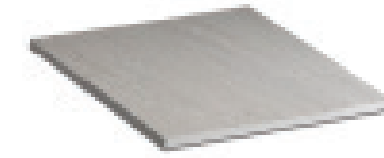

Paving

Size (cm)	New Jersey
30x30x2.5	
30x60x2.5	
60x60x2.5	
60x90x2.5	
Pattern 2	



Rockface Treads

Size (in)	New Jersey
12x48x2	
14x48x2	
18x48x2	
24x48x2	



Bullnose Coping

Size (in)	New Jersey
12x48x2	



Oakville Hampton Limestone

CLASSIFICATION

LIMESTONE

FINISH

FLAMED AND BRUSHED

ORIGIN

CHINA



Oakville Hampton Limestone



Paving

Size (cm)	Toronto
30x30x2.5	🇨🇦
30x60x2.5	🇨🇦
45x60x2.5	🇨🇦
60x60x2.5	🇨🇦
60x90x2.5	🇨🇦
Pattern 1	🇨🇦



Rockface Treads

Size (in)	Toronto
12x48x2	🇨🇦
12x60x2	🇨🇦
12x72x2	🇨🇦
14x48x2	🇨🇦
14x72x2	🇨🇦
16x48x2	🇨🇦
16x72x2	🇨🇦



Steps

Size (in)	Toronto
16x48x7	🇨🇦
16x60x7	🇨🇦
16x72x7	🇨🇦
16x96x7	🇨🇦



BBQ Slabs ❤️

Size (in)	Toronto
36x96x2	🇨🇦
48x96x2	🇨🇦



Bullnose Coping

Size (in)	Toronto
12x48x2	🇨🇦



Edge Pavers ❤️

Size (cm)	Toronto
30x60x2.5	🇨🇦



Fillers ❤️

Size (in)	Toronto
6x31x7	🇨🇦



Pier Caps ❤️

Size (in)	Toronto
24x24x3	🇨🇦
28x28x3	🇨🇦



Wall Caps ❤️

Size (in)	Toronto
14x48x2	🇨🇦



Straight Edge Coping

Size (in)	Toronto
12x48x2	🇨🇦



Rebated Treads

Size (in)	Toronto
12x48x2	🇨🇦

Oakville Highland Black



CLASSIFICATION

GRANITE

FINISH

FLAMED

ORIGIN

CHINA



Paving

Size (cm)	Toronto
30x60x2.5	🇨🇦
45x60x2.5	🇨🇦
60x60x2.5	🇨🇦
60x90x2.5	🇨🇦



BBQ Slabs

Size (in)	Toronto
36x96x2	🇨🇦



Bullnose Coping

Size (in)	Toronto
12x48x2	🇨🇦



Rockface Treads

Size (in)	Toronto
12x48x2	🇨🇦
12x72x2	🇨🇦
14x48x2	🇨🇦
16x48x2	🇨🇦
16x72x2	🇨🇦



Straight Edge Coping

Size (in)	Toronto
12x48x2	🇨🇦



Pier Caps

Size (in)	Toronto
24x24x3	🇨🇦
28x28x3	🇨🇦



Steps

Size (in)	Toronto
16x48x7	🇨🇦
16x60x7	🇨🇦
16x72x7	🇨🇦
16x96x7	🇨🇦



Fillers

Size (in)	Toronto
6x31x7	🇨🇦



Wall Caps

Size (in)	Toronto
14x48x2	🇨🇦

Oakville Imperial Black

CLASSIFICATION

QUARTZITIC SANDSTONE

FINISH

NATURAL CLEFT

ORIGIN

INDIA



Oakville Imperial Black

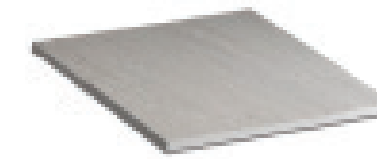

Paving

Size (cm)	Toronto
30x60x2.5	🇨🇦
45x60x2.5	🇨🇦
60x60x2.5	🇨🇦
60x90x2.5	🇨🇦
Pattern 1	🇨🇦



Rockface Treads

Size (in)	Toronto
12x48x2	🇨🇦
16x48x2	🇨🇦



Steps

Size (in)	Toronto
16x48x7	🇨🇦
16x60x7	🇨🇦
16x72x7	🇨🇦



Edge Pavers

Size (cm)	Toronto
30x60x2.5	🇨🇦



Wall Caps

Size (in)	Toronto
14x48x2	🇨🇦



Oakville Ivory Coast

CLASSIFICATION

QUARTZITIC SANDSTONE

FINISH

SANDBLASTED

ORIGIN

INDIA



Oakville Ivory Coast



BBQ Slabs

Size (in)	Toronto	Savannah
36x96x2		



Bullnose Coping

Size (in)	Toronto	Savannah
12x48x2		



Fillers

Size (in)	Toronto
6x31x7	



Straight Edge Coping

Size (in)	Toronto
12x48x2	



Paving

Size (cm)	Toronto
30x30x2.5	
30x60x2.5	
45x60x2.5	
60x60x2.5	
60x90x2.5	
Pattern 1	



Rockface Treads

Size (in)	Toronto	Savannah
12x48x2		
12x72x2		
14x72x2		
16x48x2		
16x72x2		



Steps

Size (in)	Toronto
16x48x7	
16x60x7	
16x72x7	



Pier Caps

Size (in)	Toronto
24x24x3	
28x28x3	



Wall Caps

Size (in)	Toronto
14x48x2	



Oakville Rainbow

CLASSIFICATION
SANDSTONE

FINISH
HONED

ORIGIN
INDIA



Oakville Rainbow



Paving

Size (cm)	New Jersey
Pattern 2	



Rockface Treads

Size (in)	New Jersey
12x48x2	
12x60x2	
12x72x2	
12x96x2	
14x72x2	
18x72x2	
24x72x2	

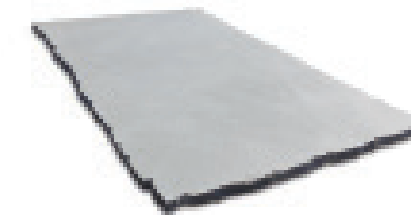

Slabs

Size (in)	New Jersey
36x72x2	



Bullnose Coping

Size (in)	New Jersey
12x48x2	

Oakville Rustic Plains

CLASSIFICATION
SANDSTONE

FINISH
NATURAL CLEFT

ORIGIN
INDIA



Oakville Rustic Plains

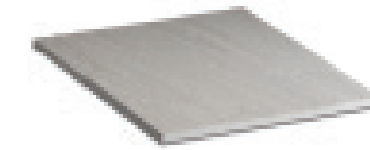

Paving

Size (cm)	New Jersey	Savannah
30x30x2.5		
30x60x2.5		
60x60x2.5		
60x90x2.5		
Pattern 2		



Rockface Treads

Size (in)	New Jersey	Savannah
12x48x2		
14x48x2		
18x48x2		
24x48x2		



Bullnose Coping

Size (in)	New Jersey
12x48x2	

Oakville Sagebrush

CLASSIFICATION

QUARTZITIC SANDSTONE

FINISH

NATURAL CLEFT

ORIGIN

INDIA



Oakville Sagebrush



Steps

Size (in)	Toronto
16x36x7	🇨🇦
16x48x7	🇨🇦
16x60x7	🇨🇦
16x72x7	🇨🇦
16x96x7	🇨🇦



Bullnose Coping

Size (in)	Toronto	Savannah
12x48x2	🇨🇦	🇺🇸



Edge Pavers

Size (cm)	Toronto
30x60x2.5	🇨🇦



Fillers

Size (in)	Toronto
6x31x7	🇨🇦



Paving

Size (cm)	Toronto
30x30x2.5	🇨🇦
30x60x2.5	🇨🇦
45x60x2.5	🇨🇦
60x60x2.5	🇨🇦
60x90x2.5	🇨🇦
Pattern 1	🇨🇦



Rockface Treads

Size (in)	Toronto
12x48x2	🇨🇦
12x60x2	🇨🇦
12x72x2	🇨🇦
14x48x2	🇨🇦
14x72x2	🇨🇦
16x48x2	🇨🇦
16x72x2	🇨🇦



Pier Caps

Size (in)	Toronto
24x24x3	🇨🇦
28x28x3	🇨🇦



Wall Caps

Size (in)	Toronto
14x48x2	🇨🇦



Oakville Siberian Grey



CLASSIFICATION
LIMESTONE

FINISH
SANDBLASTED

ORIGIN
CHINA



Paving

Size (cm)	Toronto
30x30x3	🇨🇦
30x60x3	🇨🇦
45x60x3	🇨🇦
60x60x3	🇨🇦
60x90x3	🇨🇦
Pattern 1	🇨🇦



Rockface Treads

Size (in)	Toronto
12x48x2	🇨🇦
14x48x2	🇨🇦
16x48x2	🇨🇦



Bullnose Coping

Size (in)	Toronto
12x48x2	🇨🇦



Straight Edge Coping

Size (in)	Toronto
12x48x2	🇨🇦
14x48x2	🇨🇦
16x48x2	🇨🇦



Pier Caps

Size (in)	Toronto
24x24x3	🇨🇦
28x28x3	🇨🇦



Wall Caps

Size (in)	Toronto
14x48x2	🇨🇦



Steps

Size (in)	Toronto
16x48x7	🇨🇦
16x60x7	🇨🇦



Fillers

Size (in)	Toronto
6x31x7	🇨🇦



Oakville Silver Pearl



CLASSIFICATION

LIMESTONE

FINISH

SANDBLASTED & BRUSHED

ORIGIN

MOROCCO



Paving

Size (cm)	Savannah
30x60x2.5	
60x60x2.5	
60x90x2.5	
Pattern 1	



Bullnose Coping

Size (in)	Savannah
12x48x2	
14x48x2	



Straight Edge Coping

Size (in)	Savannah
12x48x2	
14x48x2	

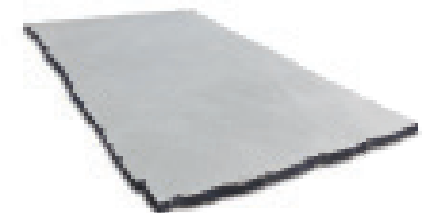

Slabs

Size (in)	Savannah
60x115x2	

Oakville Slate Grey

CLASSIFICATION

QUARTZITIC SANDSTONE

FINISH

NATURAL CLEFT

ORIGIN

INDIA



Oakville Slate Grey



Bullnose Coping

Size (in)	Toronto	New Jersey	Savannah
12x48x2	🇨🇦	🇺🇸	🇺🇸



BBQ Slabs

Size (in)	Toronto	New Jersey	Savannah
36x96x2	🇨🇦	🇺🇸	🇺🇸
48x96x2	🇨🇦		



Edge Pavers

Size (cm)	Toronto
30x60x2.5	🇨🇦



Fillers

Size (in)	Toronto
6x31x7	🇨🇦



Pier Caps

Size (in)	Toronto
24x24x3	🇨🇦
28x28x3	🇨🇦



Wall Caps

Size (in)	Toronto	New Jersey
12x48x2	🇨🇦	
14x48x2	🇨🇦	🇺🇸



Paving

Size (cm)	Toronto	New Jersey	Savannah
30x30x2.5	🇨🇦	🇺🇸	
30x60x2.5	🇨🇦	🇺🇸	🇺🇸
45x60x2.5	🇨🇦	🇺🇸	
45x90x2.5		🇺🇸	
60x60x2.5	🇨🇦	🇺🇸	🇺🇸
60x90x2.5	🇨🇦	🇺🇸	🇺🇸
Pattern 1	🇨🇦		🇺🇸
Pattern 2		🇺🇸	



Rockface Treads

Size (in)	Toronto	New Jersey	Savannah
12x48x2	🇨🇦		🇺🇸
12x60x2	🇨🇦		
12x72x2	🇨🇦	🇺🇸	
12x96x2		🇺🇸	
14x48x2	🇨🇦		
14x72x2	🇨🇦	🇺🇸	
14x96x2	🇨🇦		
16x48x2	🇨🇦		
16x72x2	🇨🇦		
18x72x2		🇺🇸	
24x72x2		🇺🇸	



Steps

Size (in)	Toronto	New Jersey
16x48x6	🇨🇦	
16x72x6	🇨🇦	
16x48x7	🇨🇦	🇺🇸
16x60x7	🇨🇦	
16x72x7	🇨🇦	🇺🇸
16x96x7	🇨🇦	



Straight Edge Coping

Size (in)	Toronto	New Jersey	Savannah
12x48x2	🇨🇦	🇺🇸	🇺🇸



Rebated Treads

Size (in)	Toronto
12x48x2	🇨🇦



Hollow Steps

Size (in)	Toronto
16x48x7	🇨🇦

Oakville Thermal Bluestone

CLASSIFICATION

SANDSTONE

FINISH

FLAMED

ORIGIN

ITALY



Oakville Thermal Bluestone



Paving

Size (in)	New Jersey	Savannah
11.5x11.5x1		
11.5x23.5x1		
17.5x17.5x1		
17.5x23.5x1		
17.5x35.5x1		
23.5x23.5x1		
23.5x35.5x1		
Pattern 2		



Straight Edge Coping

Size (in)	New Jersey	Savannah
12x48x2		
12x60x2		
12x72x2		
12x96x2		
14x72x2		
14x96x2		
18x72x2		
18x96x2		
24x72x2		
24x96x2		



Bullnose Coping

Size (in)	New Jersey	Savannah
14x48x2		

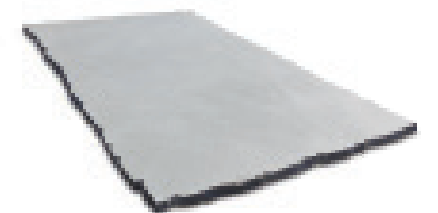

Slabs

Size (in)	New Jersey	Savannah
60x115x2 (Avg)		
60x115x2 (Avg) Polished		

APPLIC ATIONS

PAVING

Sawn on Four Sides

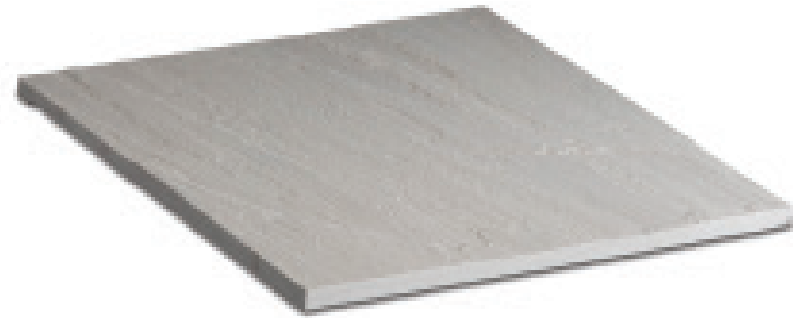

Metric Size (cm)	Toronto	New Jersey	Savannah
30x30x2.5			
30x60x2.5			
45x45x2.5			
45x60x2.5			
45x90x2.5			
60x60x2.5			
60x90x2.5			
Pattern 1			
Pattern 2			

2.5 = 1" | 30 = 11.81" | 45 = 17.72" | 90 = 35.43"

*Oakville Brown Wave is 3cm (1.25") thick

PATTERN CRATES

Crated Premixed Pattern

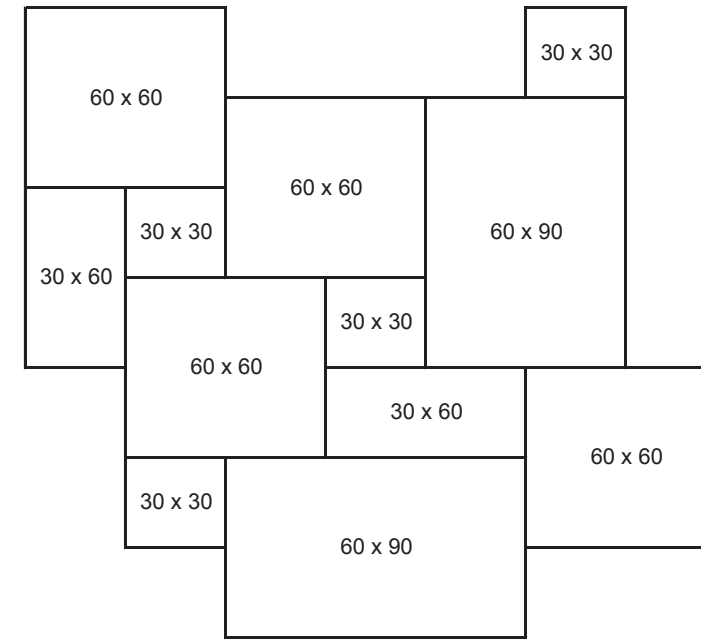

Pattern 1

Size (cm)	Number of Pcs	Sqft
30x30	24	24
30x60	12	24
60x60	24	96
60x90	12	72
Total	72	216

- * Metric paving can be laid with or without a joint. If using a joint, 1/4" maximum.
- * Each crate contains 6 modules of 36 sqft of the pattern layout to the left.
- * Total square footage in each crate is 216 sqft.

Pattern 2

Size cm & (in)	Number of Pcs	Sqft
30x30 (11.5x11.5)	5	5
30x45 (11.5x17.5)	6	9
30x60 (11.5x23.5)	6	12
30x75 (11.5x29.5)	1	2.5
45x45 (17.5x17.5)	6	13.5
45x60 (17.5x23.5)	9	27
45x75 (17.5x29.5)	4	15
60x60 (23.5x23.5)	4	16
Total	41	100

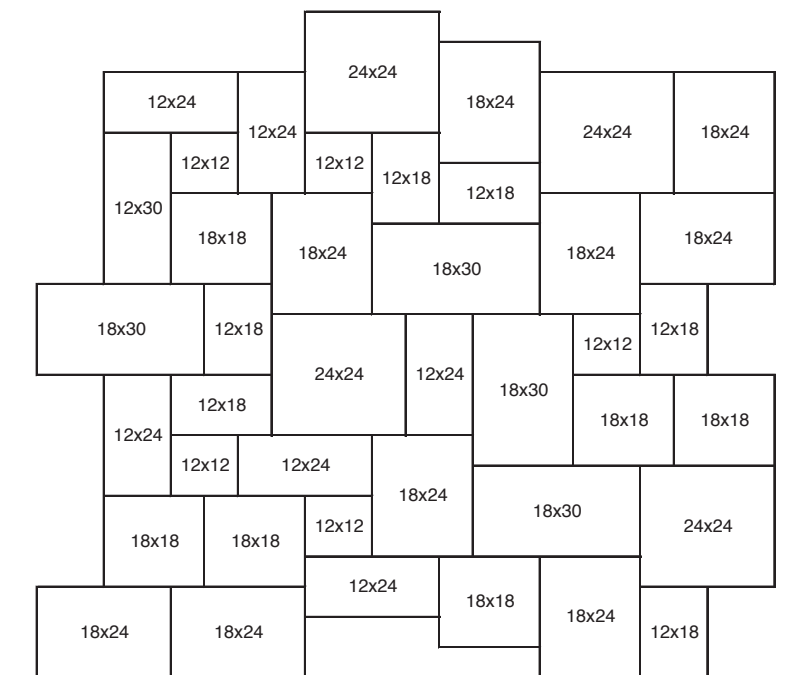

- * Metric paving can be laid with or without a joint. If using a joint, 1/4" maximum.
- * Imperial paving must be laid with a 1/2" joint.
- * Each crate contains 2 modules of 100 sqft each of the pattern layout to the right.
- * Total square footage in each crate is 200 sqft.

HANDCUT PAVING

Hand Chiseled on Four Sides



Size	New Jersey	Savannah
Pattern 1		



EDGE PAVERS

Rockfaced on One Long Side



Size (cm)	Toronto
30x60x2.5	



ROCKFACE TREADS

Rockfaced on One Long Side

Size (in)	Toronto	New Jersey	Savannah
12x48x2	🇨🇦	🇺🇸	🇺🇸
12x60x2	🇨🇦	🇺🇸	
12x72x2	🇨🇦	🇺🇸	🇺🇸
12x96x2		🇺🇸	
14x48x2	🇨🇦	🇺🇸	
14x72x2	🇨🇦	🇺🇸	🇺🇸
14x96x2	🇨🇦	🇺🇸	
16x48x2	🇨🇦		
16x72x2	🇨🇦		
18x48x2		🇺🇸	
18x72x2		🇺🇸	🇺🇸
18x96x2		🇺🇸	
24x48x2		🇺🇸	
24x72x2		🇺🇸	🇺🇸
24x96x2		🇺🇸	



REBATED TREADS

Rockfaced on One Long Side



Size (in)	Toronto
12x48x2	🇨🇦



BULLNOSE COPING

Finished Bullnose on One Long Side









Size (in)	Toronto	New Jersey	Savannah
12x48x2			
14x48x2			



STRAIGHT EDGE COPING

Finished on One Long Side



Size (in)	Toronto	New Jersey	Savannah
12x48x2			
14x48x2			
16x48x2			



STEPS

Rockfaced on One Long and Two Short Sides



Size (in)	Toronto	New Jersey
16x48x6	🇨🇦	
16x72x6	🇨🇦	
16x96x6	🇨🇦	
16x36x7	🇨🇦	
16x48x7	🇨🇦	🇺🇸
16x60x7	🇨🇦	
16x72x7	🇨🇦	🇺🇸
16x96x7	🇨🇦	



FILLERS

Rockfaced on One or Two Long Sides



Size (in)	Toronto
6x31x7	🇨🇦



PIER CAPS

Rockfaced on All Four Sides



Size (in)	Toronto	New Jersey
24x24x3		
28x28x3		



WALL CAPS

Rockfaced on All Four Sides



Size (in)	Toronto	New Jersey
12x48x2		
14x48x2		



BBQ SLABS

Rockfaced on All Four Sides



Size (in)	Toronto	New Jersey	Savannah
36x72x2			
36x96x2			
48x96x2			



SLABS

Sawn or Split on Four Sides



Size (in)	New Jersey	Savannah
36x72x2		
48x96x2		
60x115x2 (Avg)		
60x115x2 (Avg) Polished		



INSTAL LATION

STEPS AND FILLERS GENERIC INSTALLATION

MATERIAL REQUIREMENTS

STEPS

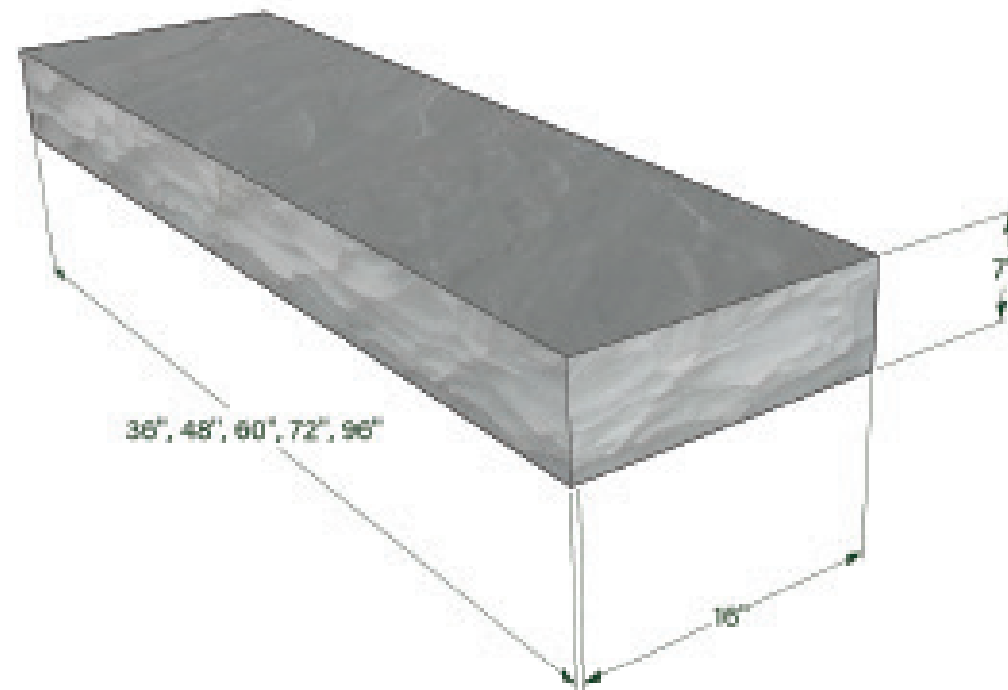

FILLERS



STEP 1

Place one Step and two full Fillers as shown

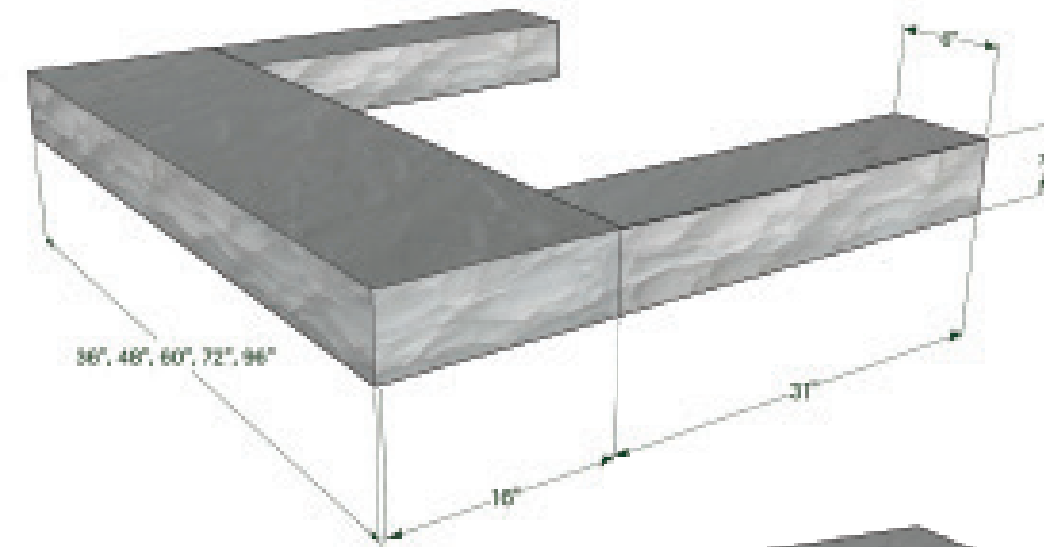

STEP 2

Place second Step with an approximately $\frac{3}{4}$ " overlap

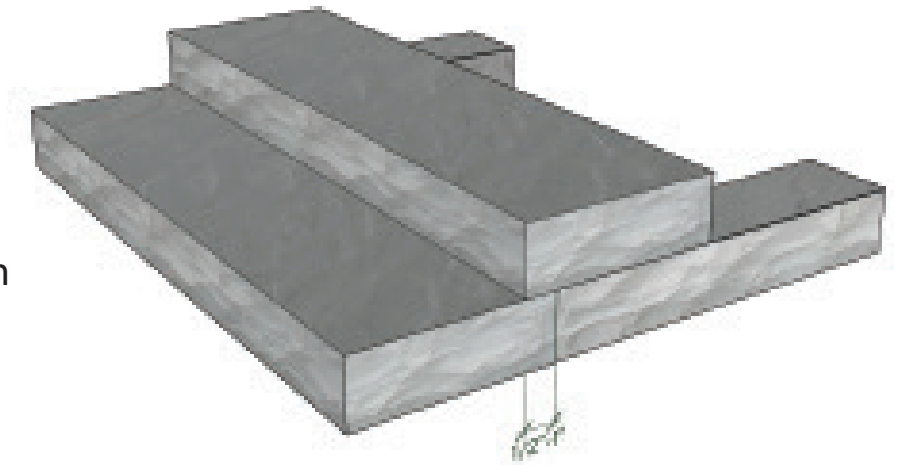

STEP 3

Cut one Filler into two equal pieces and place it behind the second Step

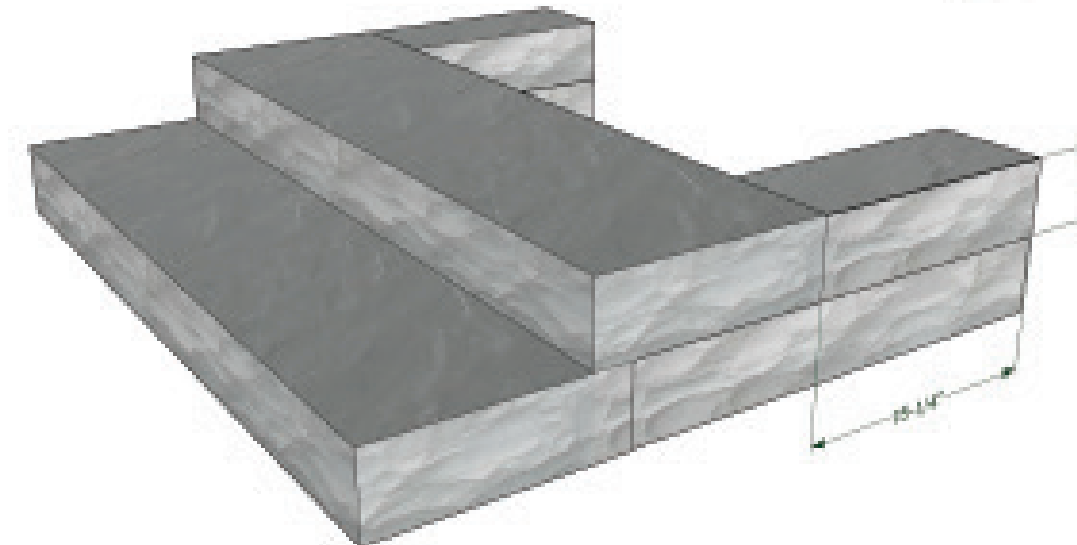

STEP 4

Place the third Step with a $\frac{3}{4}$ " overlap



DRY LAY INSTALLATION

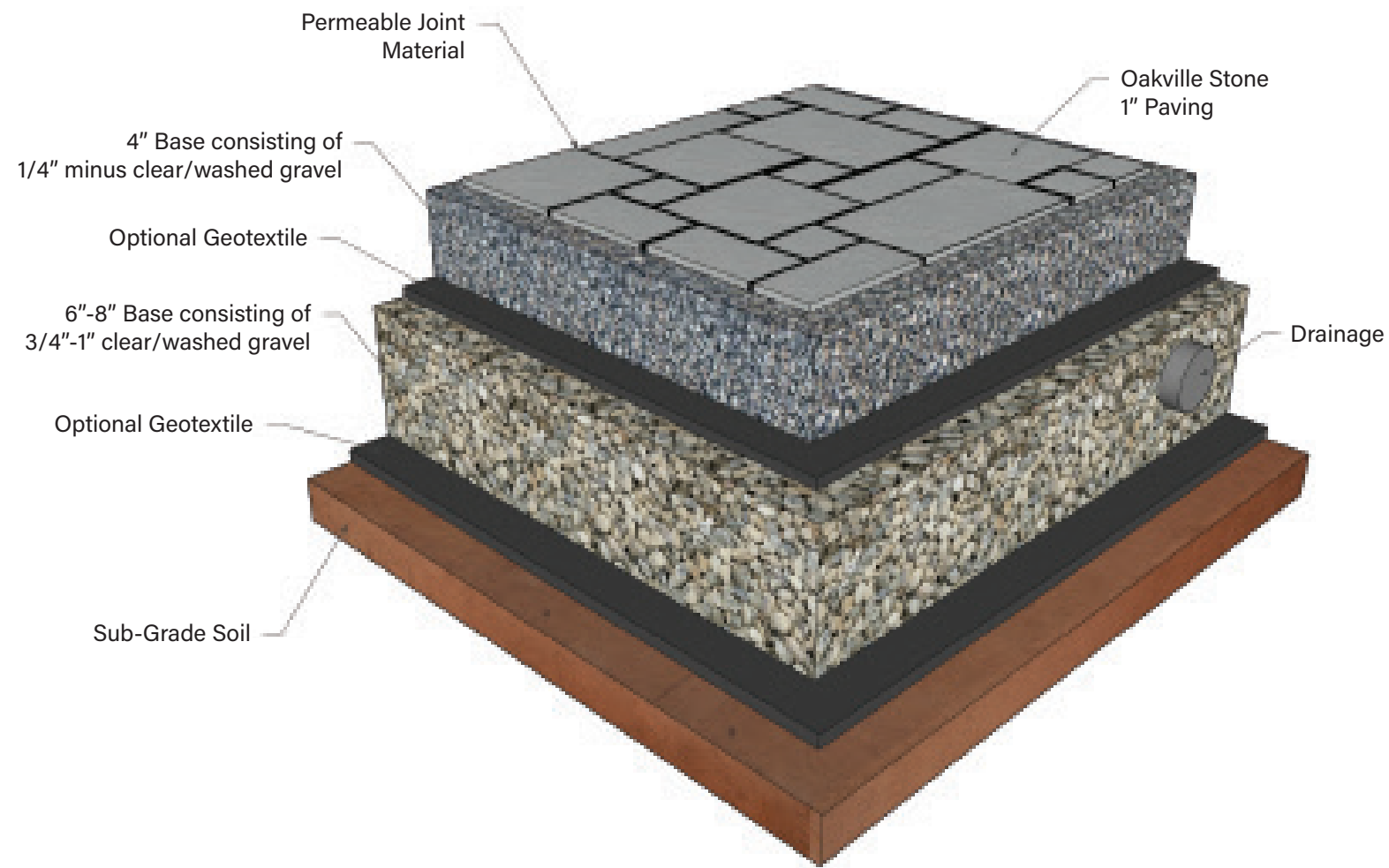

- Joint spacing between stone paving will vary based on sizes installed.
- Use of edge restraint is highly recommended.

WET LAY INSTALLATION

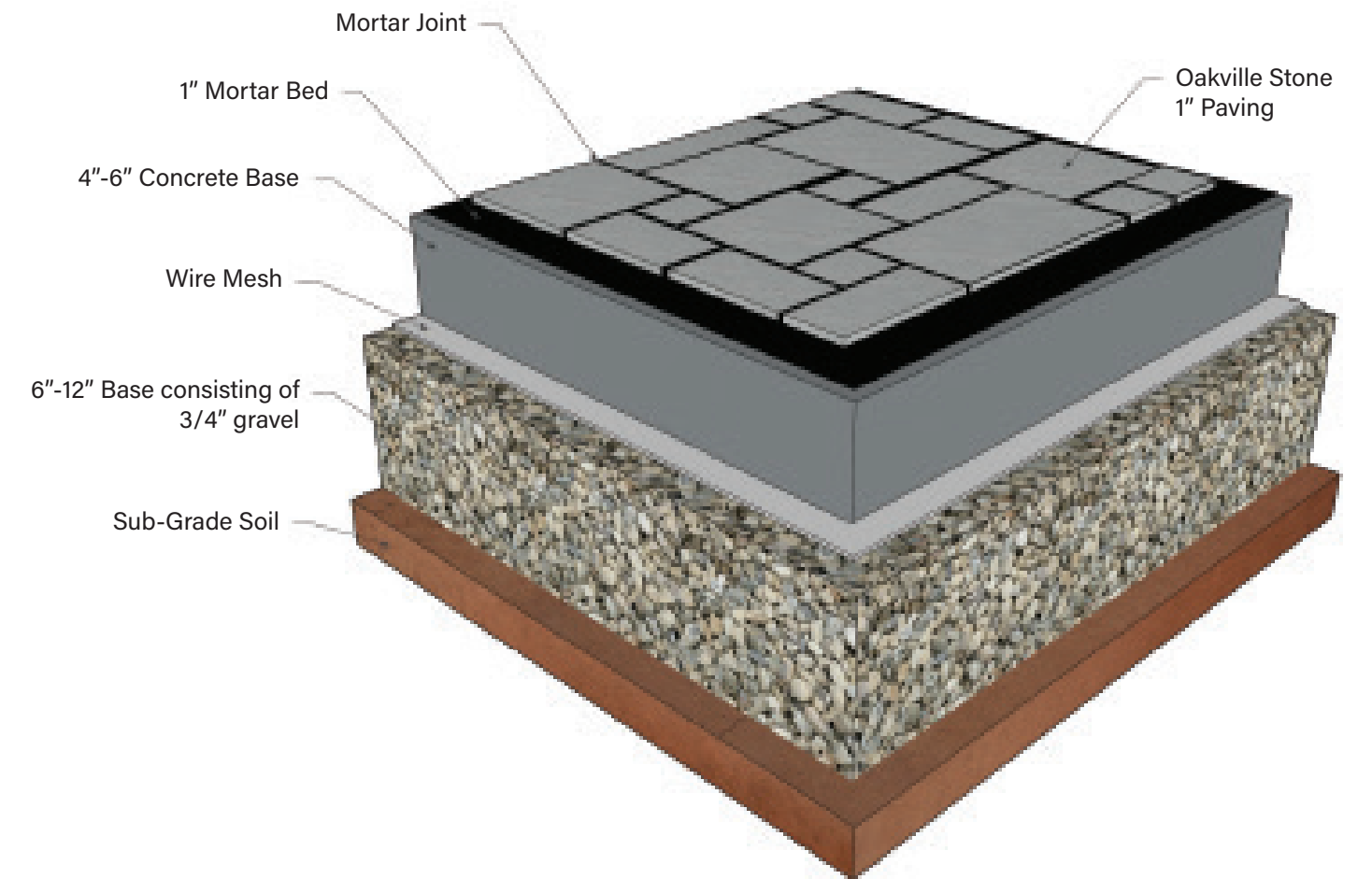

- Joint spacing between stone paving will vary based on sizes installed.
- Use of bonding agent in mortar mix is highly recommended.
- Back butter of paving before installation is highly recommended.

CONSIDERATIONS WHEN

USING NATURAL STONE

COLOR VARIATION

Stone is a product of nature, and should be appreciated for all the natural characteristics it beholds. Just as no snowflake is alike, no natural stone is alike (even if it is from the same quarry). It is because of this uniqueness that stone is often chosen, but also, sometimes misunderstood. Often the natural color range and texture variation is the source of this misunderstanding. To avoid this, one should first accept that natural stone has natural variation in color and texture. Sawn and finished stone (honed, flamed, sandblasted, etc.) will have minimal variation in texture. Secondly one should decide on the stone of their choice after seeing several full-size pieces laid out.

MAINTENANCE

Natural stone will last a lifetime with little maintenance. However, if you are the type that wants to keep your natural stone installation looking as close to as it did when it was first installed, some regular maintenance will be required. At minimum, regularly sweep to ensure loose dirt or fallen leaves do not sit on the stone for prolonged periods of time. Do not drive or allow heavy equipment to be driven on areas where the base would not support such weight. Do not allow oils or acids (acidic liquids) to come in contact with the stone. If using a gas or charcoal grill, ensure you cover the area with a grill mat to protect your natural stone patio or deck.

CLEANING

As referenced above, regular maintenance, including cleaning, should be performed from time to time on your natural stone installation. However, at no time should any cleaner containing muriatic or hydrochloric acid be used on any type of natural stone (including Oakville Stone). The use of these harsh acids is not only bad for the stone and dangerous to oneself, but also very toxic to the environment including plants and animals. If organic stains from soils, moss, mold, or leaves occur, it is best to first try cleaning with a mild soap solution, a stiff deck brush, and water. If required, a pressure washer is also acceptable (ensure that the nozzle is not set to the most concentrated stream to avoid the risk of damaging the stone). If the stains persist, there are many natural stone cleaning products on the market that have been proven to work well and not harm the stone (please consult with your local dealer for products they recommend on natural stone).

POLYMERIC HAZE

Polymeric haze is a result of polymeric sand not being properly removed from the surface of the paving when installed. The hazing will naturally disappear over time with rainfall and wear and there are several cleaners to remove the haze. Please consult your installer for the appropriate cleaner and what to expect if choosing to chemically clean this residue. Since this is entirely an installation issue, Oakville Stone does not take any responsibility for the occurrence or removal of polymeric haze.

STONE TESTING

ASTM is the abbreviation for the American Society for Testing and Materials. ASTM is an international standards organization that develops and publishes technical standards for a wide range of materials and products. Before proceeding with any new stone, it is our practice to first have it tested under the ASTM laboratory testing standards. The four most common categories under ASTM testing in the stone industry are: compressive strength, flexural strength, absorption, and density. Upon request we can provide the results from these tests for each and every one of our stone products.

SEALING

The sealing of natural stone is a hotly debated subject in our industry. Traditionalists contend that natural stone should never be sealed and one should enjoy it as it weathers and ages over time. Proponents of sealing report that it helps reduce maintenance and potential stains and/or discoloration. Our company takes a balanced approach. In our opinion sealing or not sealing is entirely a personal choice. Choosing either option will not adversely affect the life of Oakville Stone products. However, one should be aware of the possible outcomes of each choice. When choosing not to seal your natural stone, one should expect to either accept some slight fading over time and potential organic staining if not regularly maintained (swept or sprayed with water). If one chooses to seal, it is important to first confirm whether the sealer being used is suitable for that particular stone and installation type, and to read and follow the manufacturer's instructions carefully to ensure it is applied correctly. Before proceeding with any type of natural stone sealer or cleaner, be sure to first test it in an inconspicuous area.

Two important things to ensure if choosing a sealer are:

- 1- Is it suitable for that stone type? (usually clearly marked on the sealer label)
- 2- Is it breathable?

Once these points are satisfied, there are more choices such as solvent, water based, natural look, color enhance.

EFFLORESCENCE

Efflorescence is a naturally occurring process which sometimes appears in the form of a white powdery film on the surface of stone, brick, or concrete pavers. In stone products, it seldomly originates from the stone, but instead from either the brick or concrete in the stone's proximity or the cement with which the stone was laid. Efflorescence, in no way, hinders the quality and function of the stone. Before employing the use of a chemical efflorescence cleaner, first try pressure washing or scrubbing the affected area. The other method is to do absolutely nothing as this phenomenon will typically lessen or dissipate over time when exposed to the elements (rain, snow, and wear).

SNOW REMOVAL

Use of a plastic shovel is the most appropriate way of removing snow from natural stone. Use of a metal shovel can scrape and damage the surface of the stone or leave behind small remnants of steel that could turn rusty. Similarly, use of snow blowers that have a plastic shoe instead of a metal shoe is recommended. The use of salt is not recommended as it has various disadvantages. Firstly, salt can cause discoloration as it acts as a bleach. This can result in colored spots throughout the surface of the stone. Secondly, salt when mixed with melted snow and ice creates a brine that may permeate the stone and the joints and slowly corrode these materials. The safest method to ensure safety without adversely affecting the stone is to first remove as much snow as possible with a plastic shovel, then use either untreated sand or kitty litter. This will provide grip during the winter months and in the spring, a nice soil amendment when swept into the garden.

LAYING TECHNIQUES

To ensure a beautiful installation, we recommend when laying our stone paving to be sure to pick pieces from at least two or three different crates. This will ensure a good mix of color and texture variation and a spectacular end result.

STOCKING LOCATION GUIDE



Paving p72

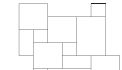

Pattern Crates p73



Handcut Paving p74



Edge Pavers p75



Rockface Treads p76



Rebated Treads p77



Bullnose Coping p78



Straight Edge Coping p79



Steps p80



Fillers p81



Pier Caps p82



Wall Caps p83



BBQ Slabs p84



Slabs p85

Oakville Antique Limestone						
Oakville Autumn Brown						
Oakville Black Limestone						
Oakville Blue Ice						
Oakville Brown Wave						
Oakville Buff						
Oakville Hampton Limestone						
Oakville Highland Black						

Toronto, Canada New Jersey Savannah, Georgia

STOCKING LOCATION GUIDE

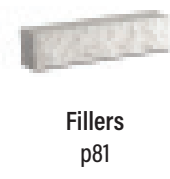
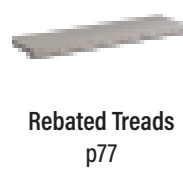
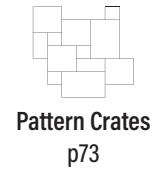

Oakville Imperial Black						
Oakville Ivory Cost						
Oakville Rainbow						
Oakville Rustic Plains						
Oakville Sagebrush						
Oakville Siberian Grey						
Oakville Silver Pearl						
Oakville Slate Grey						
Oakville Thermal Bluestone						

Toronto, Canada New Jersey Savannah, Georgia



Oakville Slate Grey



OAKVILLE STONE

Toronto | New Jersey | Savannah

960 Kamato Road,
Mississauga, Ontario, L4W 2R6, Canada

T: 905-270-1110 F: 905-270-1160

www.oakvillestone.com